

Translation of the original instructions

# Vacuum packaging machines Single chamber machines Industrial models (I3000, I5000, I7000)



**⚠ Before starting work, read these instructions!**

**ERME AG SWISS VACUUM SOLUTIONS**

Grossmattstrasse 25  
CH-8964 Rudolfstetten

T +41 (0)56 633 74 18  
F +41 (0)56 633 75 18

erme.ch  
info@erme.ch

Revision status: 1.0  
Date of issue: October 2017

This manual is protected by copyright and is exclusively for internal purposes. Transfer of this manual to third parties, reproductions in any manner and form – in full or in part – as well as exploitation and/or communication of content without written permission from the manufacturer, except for internal purposes, is prohibited.

# Table of contents

|          |  |           |
|----------|--|-----------|
| <b>1</b> | <b>General information.....</b>            | <b>6</b>  |
| 1.1      | Subject of these instructions.....         | 6         |
| 1.2      | Target group.....                          | 6         |
| 1.3      | Target group.....                          | 7         |
| 1.4      | Information about these instructions.....  | 7         |
| 1.4.1    | Information about the content.....         | 7         |
| 1.4.2    | Instructions for use.....                  | 8         |
| 1.4.3    | Used symbols.....                          | 9         |
| 1.4.4    | Structure of the warning messages.....     | 10        |
| 1.5      | Additional sources of information.....     | 12        |
| 1.6      | Limitations of liability.....              | 12        |
| 1.7      | Copyright protection.....                  | 13        |
| 1.8      | Warranty provisions.....                   | 13        |
| 1.9      | Customer service.....                      | 13        |
| 1.10     | Product monitoring.....                    | 13        |
| <b>2</b> | <b>Safety.....</b>                         | <b>14</b> |
| 2.1      | General information.....                   | 14        |
| 2.2      | Intended use.....                          | 14        |
| 2.2.1    | Foreseeable misuse.....                    | 14        |
| 2.3      | Basic safety instructions.....             | 15        |
| 2.4      | Special dangers / residual risks.....      | 16        |
| 2.4.1    | Danger due to electrical current.....      | 16        |
| 2.4.2    | Danger due to hot surfaces.....            | 16        |
| 2.4.3    | Danger due to pressurised components.....  | 17        |
| 2.4.4    | Danger due to oxygen-displacing gases..... | 17        |
| 2.4.5    | Risk of crushing.....                      | 17        |
| 2.5      | Emissions.....                             | 18        |
| 2.5.1    | Noise emission.....                        | 18        |
| 2.6      | The operator's responsibility.....         | 18        |
| 2.7      | Personnel requirements.....                | 19        |
| 2.7.1    | Personnel qualifications.....              | 19        |
| 2.7.2    | Unauthorised personnel.....                | 20        |
| 2.7.3    | Instruction.....                           | 20        |
| 2.8      | Personal protective equipment.....         | 21        |
| 2.9      | Safety equipment on the machine.....       | 22        |
| 2.10     | Signage on the machine.....                | 23        |
| 2.11     | Conversions prohibited.....                | 24        |
| 2.12     | Spare parts.....                           | 24        |
| 2.13     | Auxiliary and operating materials.....     | 24        |
| 2.14     | Accident prevention measures.....          | 25        |

|  |           |
|--|-----------|
| 2.14.1 Preventative measures.....                          | 25        |
| 2.14.2 Response measures in case of accidents.....         | 25        |
| 2.15 Environmental protection .....                        | 25        |
| <b>3 Technical data.....</b>                               | <b>26</b> |
| 3.1 Machine data .....                                     | 26        |
| 3.2 Ambient conditions.....                                | 29        |
| 3.3 Type plate.....  | 29        |
| <b>4 Structure and function .....</b>                      | <b>30</b> |
| 4.1 Functional description.....                            | 30        |
| 4.2 Machine overview.....                                  | 31        |
| 4.3 Control panel.....                                     | 33        |
| 4.4 Options .....  | 34        |
| 4.4.1 Inert gas.....                                       | 34        |
| 4.4.2 External control panel.....                          | 34        |
| <b>5 Transport.....</b>                                    | <b>35</b> |
| 5.1 Safety instructions .....                              | 35        |
| 5.2 Personnel qualifications .....                         | 36        |
| 5.3 Transport inspection .....                             | 36        |
| 5.4 Packaging .....  | 36        |
| <b>6 Installation .....</b>                                | <b>37</b> |
| 6.1 Safety instructions .....                              | 37        |
| 6.2 Electrical connection.....                             | 38        |
| 6.3 Connection for inert gas (option).....                 | 39        |
| <b>7 Control/operation .....</b>                           | <b>40</b> |
| 7.1 Safety instructions .....                              | 40        |
| 7.2 Requirements for the installation site .....           | 40        |
| 7.3 General instructions .....                             | 41        |
| 7.4 Information about packaged goods.....                  | 41        |
| 7.4.1 Basic machine settings .....                         | 41        |
| 7.4.2 Instructions on storage times.....                   | 41        |
| 7.4.3 Packaging liquids .....                              | 42        |
| 7.5 Switching on the machine .....                         | 42        |
| 7.6 Switching off the machine .....                        | 42        |
| 7.7 Preparing the machine .....                            | 42        |
| 7.8 Preparing the machine for injection of inert gas ..... | 43        |
| 7.9 Operating the controller CP-E5.....                    | 45        |
| 7.9.1 Setting parameters .....                             | 45        |
| 7.9.2 Editing programs.....                                | 48        |
| 7.9.3 Operating hours and cycle counters.....              | 49        |
| 7.9.4 Button lock .....                                    | 49        |

---

|           |  |           |
|-----------|--|-----------|
| 7.10      | Performing the vacuum procedure.....     | 50        |
| 7.11      | Activities after use.....                | 50        |
| <b>8</b>  | <b>Troubleshooting.....</b>              | <b>51</b> |
| 8.1       | Safety instructions.....                 | 51        |
| 8.2       | Instructions on troubleshooting.....     | 52        |
| 8.3       | Localising faults.....                   | 52        |
| <b>9</b>  | <b>Cleaning.....</b>                     | <b>53</b> |
| 9.1       | Safety instructions.....                 | 53        |
| 9.2       | Personnel qualifications.....            | 54        |
| 9.3       | Cleaning the machine.....                | 54        |
| <b>10</b> | <b>Maintenance.....</b>                  | <b>55</b> |
| 10.1      | Safety instructions.....                 | 55        |
| 10.2      | Personnel qualifications.....            | 56        |
| 10.3      | Measures prior to maintenance.....       | 56        |
| 10.4      | Maintenance report.....                  | 56        |
| 10.5      | Description of the maintenance work..... | 57        |
| 10.5.1    | Service program.....                     | 57        |
| 10.5.2    | Checking the oil level.....              | 58        |
| <b>11</b> | <b>Decommissioning and disposal.....</b> | <b>59</b> |
| 11.1      | Safety instructions.....                 | 59        |
| 11.2      | Personnel qualifications.....            | 60        |
| 11.3      | Decommissioning.....                     | 60        |
| 11.3.1    | Temporary decommissioning.....           | 60        |
| 11.3.2    | Final decommissioning / disassembly..... | 60        |
| 11.4      | Disposal.....                            | 60        |
| <b>12</b> | <b>Declaration of Conformity.....</b>    | <b>61</b> |

# 1 General information

## 1.1 Subject of these instructions

The vacuum packaging machine described here was manufactured and placed on the market by:

### **ERME AG / SWISS VACUUM SOLUTIONS**

Contact data (see Legal notice page 2)

## 1.2 Target group

In addition to the operator, the target groups for these operating instructions include:

- Operating personnel — operation and cleaning instructions.
- Maintenance personnel — troubleshooting and maintenance instructions.
- Specialists who are tasked by the operator with performing tests and maintenance work.

## 1.3 Target group

In addition to the operator, the target groups for these instructions include the:

- Operating personnel — operation and cleaning instructions.
- Maintenance personnel — troubleshooting and maintenance instructions.
- Specialists who are tasked by the unit's operator with performing tests and maintenance work.

## 1.4 Information about these instructions

### 1.4.1 Information about the content

These operating instructions contain important information about handling the machine during installation, commissioning, operation, maintenance and servicing as well as disassembly and disposal.

Compliance with all specified warning messages and instructions is a prerequisite for safely, correctly and efficiently working on and with the machine.

Observing the above information helps to prevent dangers, reduce repair costs and downtimes and increase the reliability and service life of the machine.

In addition, the local accident prevention regulations and general safety regulations applicable at the site where the machine is operated must also be observed.

Carefully read through the operating instructions before starting all work. They are part of the product and must be stored at a location where they are always accessible to the personnel.

In addition to these operating instructions, the instructions for the installed components provided by the respective supplier are located in the overall documentation. See chapter **Additional sources of information** [▶ 12].

- 1 Observe the information — in particular, the warning messages — contained therein.

## 1.4.2 Instructions for use

### Instructions and system reactions

The work steps to be carried out by the operating personnel are described consecutively. The order of the steps must be observed. The system reactions to the respective operational steps are marked by an arrow.

Example:

- ✓ Requirement
- 1 Work step 1
- ⇒ Reaction to work step 1

### Lists

Lists without a mandatory order are displayed as a list with a preceding bullet point.

Example:

- Item 1
  - Item 1, sub-item A
- Item 2

Lists with a mandatory order are displayed as a list with a preceding number.

Example:

1. First
2. Second

### References to chapters/pages

References to specific chapters in which procedures and instructions are described are illustrated as active links.

Example: (see [chapter A \[▶ 8\]](#))









## 1.4.3 Used symbols

### Pictograms

The warning messages used in these operating instructions are also provided with pictograms to clarify the type of the possible hazard.

The following pictograms are used:

| Symbol  | Meaning  |
|---|--|
|    | General warning message                          |
|    | Danger due to electricity                        |
|    | Danger due to hot surfaces                       |
|    | Risk of crushing                                 |
|   | Observe the operating instructions               |
|  | General information and helpful tips on handling |

## 1.4.4 Structure of the warning messages

The warning messages in these operating instructions are introduced by the signal words DANGER, WARNING, CAUTION and ATTENTION that express the extent of the hazard. A warning symbol also indicates the nature of the hazard.

The following warning messages are used in these operating instructions:

### Risk to life

|   |   |
|---|---|
|  | <b>⚠ DANGER</b>   |
|   | <p><b>Risk to life!</b></p> <p>Consequences of non-compliance...</p> <ul style="list-style-type: none"> <li>▶ Instructions about prevention.</li> </ul> |

A warning message of this danger level indicates an impending dangerous situation. If the dangerous situation is not prevented, it will result in death or severe, irreversible injuries.

Follow the instructions in this warning message to prevent the risk of death or severe personal injuries.

### Risk of injury

|   |   |
|---|---|
|  | <b>⚠ WARNING</b>  |
|   | <p><b>Risk of injury!</b></p> <p>Consequences of non-compliance...</p> <ul style="list-style-type: none"> <li>▶ Instructions about prevention.</li> </ul> |

A warning message of this danger level indicates a potentially dangerous situation. If the dangerous situation is not prevented, it may result in death or serious injuries.

Follow the instructions in this warning message to prevent the possible risk of death or serious personal injuries.

## Personal injuries

|   |  |
|---|--|
|  | <b>⚠ CAUTION</b>   |
|   | <p><b>Personal injuries due to...</b></p> <p>Consequences of non-compliance...</p> <p>▶ Instructions about prevention.</p> |

A warning message of this danger level indicates a potentially dangerous situation. If the dangerous situation is not prevented, it may result in light or moderate injuries.

Follow the instructions in this warning message to prevent personal injuries.

## Material damage

|  |  |
|--|--|
|  | <b>NOTICE</b>  |
|  | <p><b>Material damage due to...</b></p> <p>Consequences of non-compliance...</p> <p>▶ Instructions about prevention.</p> |

A warning message of this danger level indicates possible material damage.

If the situation is not prevented, it may result in material damage.

Follow the instructions in this warning message to prevent material damage.

## Tips and suggestions

|          |  |
|----------|--|
| <b>i</b> | <b>NOTE</b>                                |
|          | <p>Message text...</p> <p>Consequences</p> |

## 1.5 Additional sources of information

In addition to the instructions contained in these machine operating instructions, the information contained in the sources of information specified below must also be taken into consideration:

- Information about the signage on the machine
- Operating instructions for the assemblies and purchased parts that are in use
- Instructions from the operator
- Safety data sheets for auxiliary and operating materials
- Local accident prevention regulations and regional regulations at the machine operating site
- Data sheets for installed components

1 Observe the information — in particular, the safety instructions — contained therein.

## 1.6 Limitations of liability

All information and instructions provided in these operating instructions were compiled taking into consideration the applicable standards and regulations, the technological state-of-the-art as well as knowledge and experience acquired over many years.

We reserve the right to make technical modifications in the course of further developing the machine that is the subject of these operating instructions. No claims can be derived from the information, figures and descriptions provided in these operating instructions.

The manufacturer assumes no liability for damage and malfunctions due to:

- Non-compliance with these operating instructions
- Unintended use
- Personnel who are not sufficiently trained or trained at all
- Use of impermissible equipment
- Faulty connection
- Non-use of original spare parts and accessories
- Technical modifications and conversions unless they have been coordinated with the manufacturer
- Non-performance of the required maintenance work
- Performance of welding work on the machine

The manufacturer is liable for any faults or failures on our part, not including further claims arising within the context of the warranty obligations specified in the contract. Claims for compensation, regardless of the legal grounds, will be excluded.

## 1.7 Copyright protection

This documentation is protected by copyright.

We reserve all rights, including the rights of photomechanical reproduction, duplication and the distribution through special procedures (for example, data processing, data carriers and data networks), also in part, as well as the right to make content-related and technical modifications.

## 1.8 Warranty provisions

According to the Purchase Agreement, the company ERME AG provides the corresponding warranty from the delivery date of the machine.

The warranty extends to the material and manufacturing defects, which occur during normal load (single-shift operation).

The warranty excludes improper operation, incorrect electrical installations and wear parts.

Our "General Terms and Conditions" apply.

## 1.9 Customer service

Please keep the following information readily available for all contact with our customer service department:

- Machine type (see type plate on the machine)
- Purchase date (see proof of purchase)

Contact data (see Legal notice page 2)

| <b>i</b> | <b>NOTE</b>  |
|----------|--|
|          | <p>We recommend that the operator conclude a maintenance agreement with ERME AG.</p> <p>This ensures that the machine will be regularly maintained by our service personnel and also ensures the supply of necessary wear and spare parts without long delivery times.</p> |

## 1.10 Product monitoring

The company ERME AG monitors its machines up to and after delivery.

Therefore, please provide us with the following information:

- Any accidents that have occurred;
- Problems that have occurred when using the machine;
- Malfunctions that occur during specific operational situations;
- Experiences that could be important for other users.

Contact data (see Legal notice page 2)

# 2 Safety

## 2.1 General information

This chapter provides important information about all safety aspects to ensure the optimum protection of personnel as well as safe and smooth operation.

Non-compliance with the safety instructions and handling instructions specified in these operating instructions may result in significant hazards.

- 1 Make sure to observe the warning messages and instructions specified in the operating instructions.

## 2.2 Intended use

The vacuum packaging machine is only suitable for packaging solid and liquid food as well as technical products. The machine must not be used in electrostatic discharge-protected (ESD) areas.

The machine may only be used within the technical specifications and under the operating conditions defined by the manufacturer.

Any other use beyond this scope is not considered as the intended use.

The permissible values specified in the "**Technical data** [▶ 26]" section must be observed.

### 2.2.1 Foreseeable misuse

Any use for purposes other than that specified above is not intended.

The operator solely bears the risk of unintended use or misuse.

Misuse occurs, for example, if

- The machine is not used for its intended purpose.
- The information provided in these operating instructions is not strictly observed.
- Modifications are made to the machine.
- The machine is used in a potentially explosive area.
- The machine is used in electrostatic discharge-protected (ESD) departments.
- Aggressive, combustible liquids, such as petroleum, benzol, benzene, (explosive vapours!) as well as infectious substances, living beings and material whose processing violates laws or social standards are packaged.

## 2.3 Basic safety instructions

The machine is built according to the current directives, the technological state-of-the-art and the established safety rules and regulations.

Hazards and adverse effects may, however, occur when operating the machine:

- To life and limb of the user or third parties
- To life and limb of the maintenance personnel
- To the machine itself
- To other equipment

Knowledge of the safety and user instructions set out in these instructions provides the basis for safe handling and smooth operation of the machine.

Set up the machine where it is out of the reach of children.

Regularly clean the machine.

Only have service and repair work performed by the ERME customer service department or an authorised dealer.

## 2.4 Special dangers / residual risks

### 2.4.1 Danger due to electrical current

There is a risk of death when making contact with lines or components that carry current.

- Do not use the machine if electrical lines, plugs or the insulating housing are damaged. Perform checks according to the intervals for recurring tests/inspections specified in the operating instructions.
- Work on electrical equipment must only be carried out by qualified electricians or personnel under the guidance and supervision of a qualified electrician in accordance with electrical engineering regulations.
- Defects identified on the electrical components/equipment must be corrected immediately. If there is an acute danger up until that point, the machine, component or equipment must not be used in a defective condition.
- Machine parts on which inspection, maintenance and repair work are performed — if required — must be de-energised. First check that parts that have been disconnected from the power are free of voltage, then earth and short circuit them and isolate adjacent live parts.
- If work is required on live parts, involve a second person who can disconnect the main power switch in case of an emergency. Block off the work area with a red and white security chain and a warning sign. Only use insulated tools.

### 2.4.2 Danger due to hot surfaces

Hot surfaces can cause serious injuries.

The machine reaches high temperatures during operation.

- Take safety precautions against fires, burns and overheating.
- Wear personal protective equipment.
- Do not touch the machine and, in particular, the sealing bar.
- After stopping operation, let the machine sufficiently cool down.



### 2.4.3 Danger due to pressurised components

Serious injuries may occur due to components under high pressure.

- Maintenance and repair work on the inert gas equipment must only be performed by personnel especially trained for this.
- Prior to maintenance and repair work, depressurise all machine components that are under pressure (take the pressure accumulator into consideration here).
- Regularly check the pressurised components.
- Regularly replace hose lines during preventative maintenance, even if no damage is detected.
- Observe the warning messages and instructions specified in the operating instructions.
- Wear personal protective equipment when working on the machine.

### 2.4.4 Danger due to oxygen-displacing gases

Risk of suffocation due to high inert gas concentrations.

Higher concentrations of inert gas can result in suffocation, since they displace the atmospheric oxygen.

- Only operate the machine at a well-ventilated location.  
If necessary, install a device for monitoring the ambient air.
- Keep the air slots and openings free and clean.
- Make sure that the inert gas equipment is regularly checked for leaks.
- To ensure safe handling, observe the safety data sheet for the inert gas.

### 2.4.5 Risk of crushing

There is a crushing risk between the lid and the machine.

- Never use the machine without a lid lifter.
- When closing the lid, make sure that body parts do not get trapped.

## 2.5 Emissions

### 2.5.1 Noise emission

Refer to the technical data for the machine's noise emission (see "Technical data [► 26]").

To evaluate the overall noise level at the machine's operating site, observe the local noise control regulations and measure the noise if necessary.

## 2.6 The operator's responsibility

When using the machine in the commercial sector, the operator is subject to the legal obligations on occupational safety.

In addition to the occupational safety instructions provided in these operating instructions, the safety, accident prevention and environmental protection regulations applicable for the location where the machine is operated must be observed.

The operator must

- obtain information about the applicable occupational safety regulations and carry out a risk assessment to identify additional dangers, which arise due to the special working conditions at the machine's operating site. This assessment must be implemented in the form of operating instructions for the machine.
- check during the entire operating time of the machine whether the operating instructions prepared by the operator correspond with the current status of the regulations, and adapt them as necessary.
- secure dangerous areas that are created between the machine and other equipment provided by the customer.
- clearly regulate and define the responsibilities for installation, operation, maintenance and cleaning.
- define the machine operator's responsibility and authorise it to reject instructions from third parties that are detrimental to safety.
- ensure that all personnel who handle the machine have read and understood the operating instructions.  
In addition, it must also train the personnel at regular intervals and notify them of the dangers.
- ensure that these operating instructions and all other applicable regulations are readily available to the operating and maintenance personnel.
- regularly check that the personnel are working in a safe manner while remaining aware of the dangers in compliance with these operating instructions.
- provide the personnel with the required personal protective equipment.
- ensure that hearing protection is worn if the permissible noise level (85 dB(A)) is exceeded at the operating site.

The operator is also responsible for ensuring that the machine is in perfect working order. The following therefore applies:

- The operator must ensure that the cleaning and maintenance intervals defined in these operating instructions are observed.
- The operator must have all safety equipment regularly checked for proper functioning and completeness.

## 2.7 Personnel requirements

### 2.7.1 Personnel qualifications

Improper handling can result in significant personal injuries and material damages.

- Have all activities performed by appropriately qualified personnel only.

The following qualifications for various areas of activities are specified in these operating instructions:

#### Instructed person

- The instructed person has been trained using instructions provided by the operator about the work assigned to him/her and the possible hazards in case of improper behaviour.

#### Skilled personnel

- The specialised personnel can, as a result of his/her technical training, knowledge and experiences as well as knowledge of the relevant regulations, perform the work to which he/she has been assigned and independently identify and avoid possible hazards.

#### Qualified electricians

- can, as a result of his/her technical training, knowledge and experience as well as knowledge of the relevant standards and regulations, perform work on electrical machines and independently identify and avoid possible hazards.

The qualified electrician is trained for the particular operation site where he/she works and knows the relevant standards and regulations.

Only persons who can be expected to reliably perform their work are permitted to work as operating personnel. Persons whose responsiveness is impaired, e.g. by drugs, alcohol or medicines, are not permitted.

Personnel who are yet to be trained, taught, instructed or are undergoing general training may only work on the machine under constant supervision of an experienced person.

The machine may be used by persons with limited physical, sensory or mental capabilities or with insufficient experience if they are supervised or have been instructed in its safe use and have understood the associated dangers.

|          |  |
|----------|--|
| <b>i</b> | <b>NOTE</b>  |
|          | Observe the age and occupational-specific regulations that apply at the operating site when selecting personnel. |

## 2.7.2 Unauthorised personnel

Unauthorised personnel who do not fulfil the described requirements are not aware of the dangers in the work area.

- Keep unauthorised personnel away from the work area.
- In case of doubt, address the personnel and direct them out of the work area.
- Stop working as long as unauthorised personnel are in the work area.

## 2.7.3 Instruction

The personnel must be regularly instructed by the operator.

|          |  |
|----------|--|
| <b>i</b> | <b>NOTE</b>  |
|          | For better tracking, document the performance of the training programs and have the participants confirm their participation with their signature. |

## 2.8 Personal protective equipment

Personal protective equipment must be worn when performing work in order to minimise health risks.

- When performing the work, always wear the protective equipment necessary for the respective work.
- Immediately replace worn or defective protective equipment.
- Observe the signs in the work area concerning the use of personal protective equipment.

Wear the following protective equipment for all work:



Close-fitting protective work clothing with low tear strength.



Work gloves to protect against injuries.



Protective footwear with steel caps and puncture and oil-resistant safety soles.



Safety goggles to protect the eyes against flying parts and fluids.

Special protective equipment is also required when performing specific types of work. This is indicated separately in the individual chapters.

Also wear the following protective equipment for special work:



Helmet to protect the head against falling objects.



Hearing protection in environments with noise emissions > 80 dB(A).

## 2.9 Safety equipment on the machine

Missing or non-functioning safety equipment can result in severe injuries.

- Only operate the machine if all the safety equipment is fitted and functional.
- Prior to starting work, check whether the safety equipment is functional and installed correctly.
- Never disable the safety equipment.
- Make sure that the safety equipment is always freely accessible.

The machine was manufactured in accordance with the legal regulations that apply in the European Union.

The machine, however, may pose dangers if it is not operated correctly or in a proper condition. Dangerous areas that cannot be eliminated by design are fitted with safety equipment and, where necessary, marked by warning signs on the machine and by corresponding safety instructions in the operating instructions.

The machine is equipped with the following safety equipment:

- Warning signs
- Safety and pressure relief valves
- The sealing time is limited to max. 4 seconds.
- The vacuum procedure can be stopped at any time by pressing the "STOP" button.

## 2.10 Signage on the machine

Stickers and signs can become dirty or otherwise unrecognisable over time.

- Always keep all safety, warning and operating instructions in an easily readable condition.
- Immediately replace damaged signs or stickers.

The following symbols and signs are located on the machine. They refer to the immediate surroundings where they are attached.



- Sign about the vacuum pump oil:
  - Food-grade vacuum pump oil
  - NSF Nonfood Compounds Registration H1



- Type plate



- Maximum gas pressure 1.5 bar  
(Only for machines featuring the inert gas option)

## 2.11 Conversions prohibited

Any conversions and modifications on the machine, in particular, removing or manipulating the safety equipment are prohibited.

The manufacturer no longer assumes any liability or provides any warranty if unauthorised conversions or modifications are made to the machine.

The electromagnetic behaviour of the machine can be adversely affected by additions or modifications of any kind. Therefore, do not make any changes or additions to the machine without consulting or the written consent of the manufacturer.

Opening the housing is prohibited.

## 2.12 Spare parts

Risk of injury due to incorrect or faulty spare parts.

Incorrect or faulty spare parts can result in damage to and malfunctions or total failure of the machine and endanger safety.

- Only use original spare parts or spare parts approved by the manufacturer.

The manufacturer assumes no liability for damages resulting from the use of spare or wear parts that have not been approved by the manufacturer.

## 2.13 Auxiliary and operating materials

Risk of injury due to impermissible auxiliary and operating materials.

Impermissible auxiliary and operating materials can result in damage to and malfunctions or total failure of the machine and endanger safety.

- Only use auxiliary and operating materials that have been specified and approved by the manufacturer.

The manufacturer assumes no liability for damage resulting from the use of auxiliary and operating materials that have not been approved by the manufacturer.



## 2.14 Accident prevention measures

### 2.14.1 Preventative measures

- 1 Always be prepared for accidents or fires.
- 2 Keep first aid equipment (first aid kit, blankets, etc.) and fire extinguishers readily available.
- 3 Familiarise personnel with accident signaling, first aid and rescue equipment.
- 4 Keep the access roads clear for the rescue vehicles.

### 2.14.2 Response measures in case of accidents

- 1 Immediately shut down the machine.
- 2 Initiate first aid measures.
- 3 Rescue people from the danger zone.
- 4 Notify the responsible personnel at the operation site.
- 5 Alert the emergency services.
- 6 Clear the access roads for the rescue vehicles.

## 2.15 Environmental protection

The incorrect handling of environmentally hazardous substances, in particular incorrect disposal, can cause significant damage to the environment.

- Observe the **disposal instructions** [▶ 60].
- If environmentally hazardous substances are accidentally released into the environment, take suitable measures immediately. In case of doubt, notify the responsible local authorities of the damage.

# 3 Technical data

## 3.1 Machine data

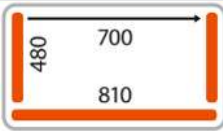
| Model  | I3000  | Unit              |
|--|--|-------------------|
| Machine dimensions<br>(width x depth x height)     | 900 x 900 x 1100   | mm                |
| Compartment dimensions<br>(width x depth x height) | 845 x 600 x 210  | mm                |
| Total weight                                       | 270  | kg                |
| Length of sealing bar                              | 2 x 480  | mm                |
|  | 1 x 810  | mm                |
| Arrangement of sealing bar                         | Left and right front<br>(U-weld)   |                   |
|  |   |                   |
| Maximum bag size                                   | 400 x 800  | mm                |
| Power supply                                       | 400  | V                 |
|  | Three-phase  |                   |
| Frequency  | 50   | Hz                |
| Suction power of vacuum pump                       | 100  | m <sup>3</sup> /h |
| Maximum vacuum pressure                            | 0.1  | mbar              |
| Nominal motor power                                | 2.7  | kW                |
| Nominal motor speed                                | 1500   | min <sup>-1</sup> |
| Mains fuse   | 16   | A                 |
| Noise emission                                     | 65   | db(A)             |
| Oil filling  | 2  | l                 |
| Possible options                                   | <ul style="list-style-type: none"> <li>– Inert gas</li> <li>– Extra high lid (280 mm)</li> <li>– Inspection glass in the lid</li> <li>– Controller located on the side, on a stainless steel arm</li> <li>– Internal stainless steel roller track</li> <li>– External stainless steel connecting roller track (10 height-adjustable rollers)</li> <li>– Volume reduction unit in the lid (3 contour plates)</li> </ul> |                   |

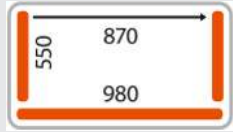
| Model  | 15000   | Unit              |
|--|---|-------------------|
| Machine dimensions<br>(width x depth x height)     | 1100 x 1000 x 1070  | mm                |
| Compartment dimensions<br>(width x depth x height) | 1015 x 675 x 210  | mm                |
| Total weight                                       | 325   | kg                |
| Length of sealing bar                              | 2 x 550   | mm                |
|  | 1 x 980   | mm                |
| Arrangement of sealing bar                         | Left and right front<br>(U-weld)  |                   |
|  |    |                   |
| Maximum bag size                                   | 550 x 900   | mm                |
| Power supply                                       | 400   | V                 |
|  | Three-phase   |                   |
| Frequency  | 50  | Hz                |
| Suction power of vacuum pump                       | 160   | m <sup>3</sup> /h |
| Maximum vacuum pressure                            | 0.1   | mbar              |
| Nominal motor power                                | 4   | kW                |
| Nominal motor speed                                | 1500  | min <sup>-1</sup> |
| Mains fuse   | 16  | A                 |
| Noise emission                                     | 70  | db(A)             |
| Oil filling  | 5   | l                 |
| Possible options                                   | <ul style="list-style-type: none"> <li>– Inert gas</li> <li>– Extra high lid (280 mm)</li> <li>– Inspection glass in the lid</li> <li>– Vacuum pump 250m<sup>3</sup>/h</li> <li>– Automatic lid</li> <li>– Controller located on the side, on a stainless steel arm</li> <li>– Internal stainless steel roller track</li> <li>– External stainless steel connecting roller track (10 height-adjustable rollers)</li> <li>– Volume reduction unit in the lid (3 contour plates)</li> </ul> |                   |

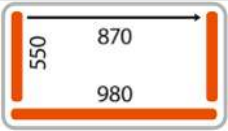
| Model  | I7000   | Unit              |
|--|---|-------------------|
| Machine dimensions<br>(width x depth x height)     | 1100 x 1000 x 1070  | mm                |
| Compartment dimensions<br>(width x depth x height) | 1015 x 675 x 210  | mm                |
| Total weight                                       | 395   | kg                |
| Length of sealing bar                              | 2 x 550   | mm                |
|  | 1 x 980   | mm                |
| Arrangement of sealing bar                         | Left and right front<br>(U-weld)  |                   |
|  |    |                   |
| Maximum bag size                                   | 550 x 900   | mm                |
| Power supply                                       | 400   | V                 |
|  | Three-phase   |                   |
| Frequency  | 50  | Hz                |
| Suction power of vacuum pump                       | 250   | m <sup>3</sup> /h |
| Maximum vacuum pressure                            | 0.1   | mbar              |
| Nominal motor power                                | 5.5   | kW                |
| Nominal motor speed                                | 1500  | min <sup>-1</sup> |
| Mains fuse   | 32  | A                 |
| Noise emission                                     | 72  | db(A)             |
| Oil filling  | 6.5   | l                 |
| Possible options                                   | <ul style="list-style-type: none"> <li>– Inert gas</li> <li>– Extra high lid (280 mm)</li> <li>– Inspection glass in the lid</li> <li>– Automatic lid</li> <li>– Controller located on the side, on a stainless steel arm</li> <li>– Internal stainless steel roller track</li> <li>– External stainless steel connecting roller track (10 height-adjustable rollers)</li> <li>– Volume reduction unit in the lid (3 contour plates)</li> </ul> |                   |

## 3.2 Ambient conditions

| Information                                 | Value       | Unit |
|---|-------------|------|
| Operating ambient temperature range         | +10 ... +30 | °C   |
| Max. operating humidity<br>(non-condensing) | 80          | %    |
| Max. altitude above sea level               | 2000        | m    |

## 3.3 Type plate



Fig. 1: Type plate

The type plate is located on the rear of the machine and contains the following information:

- Manufacturer address
- CE label
- Model designation
- Year of manufacture
- Mains connection
- Power
- Motor current
- ID no.
- Serial no.

# 4 Structure and function

## 4.1 Functional description

The vacuum packaging machine is only suitable for packaging solid and liquid food as well as technical products. The machine must not be used in electrostatic discharge-protected (ESD) areas.

The product is filled in a vacuum bag. It is then inserted into the vacuum chamber in the machine.

The air is extracted from the bag with the packaged goods using a vacuum pump. The bag is then sealed using the sealing bar.

The higher the set vacuum value, the stronger/tighter the product is packaged.

With machines fitted with an inert gas unit (option), the corresponding gas is routed into the vacuum chamber via an externally connected gas cylinder. Despite the high vacuum values, this allows for pressure-balanced packaging.

## 4.2 Machine overview



Fig. 2: Machine front

|                           |                                    |
|---------------------------|------------------------------------|
| 1 Handle                  | 2 Lid seal                         |
| 3 Sealing bar             | 4 Pressure bar with silicone strip |
| 5 Inert gas lance         | 6 Control panel of controller      |
| 7 Locking brake           | 8 Transport rollers                |
| 9 Machine housing         | 10 Main machine switch             |
| 11 Lid locking mechanism  | 12 Insertion plates                |
| 13 Protected suction unit | 14 Lid                             |



*Fig. 3: Machine rear*

15 Mains plug

16 Power supply for sealing bar in the lid

17 Ventilation slots



### 4.3 Control panel

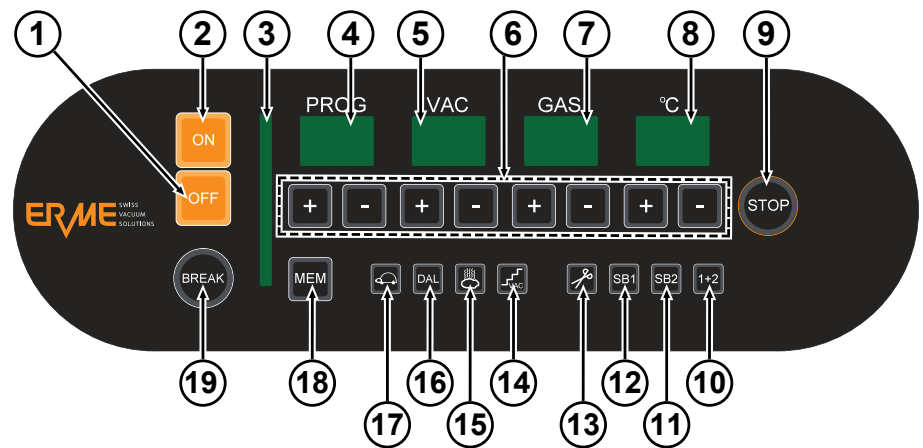

Fig. 4: Controller CP-E5

| Item | Controller          | Function   |
|------|---------------------|--|
| 1    | "OFF" button        | Switches the machine controller off.   |
| 2    | "ON" button         | Switches the machine controller on.  |
| 3    | Luminous strip      | Vacuum indicator.  |
| 4    | "PROG" display      | Program number display.  |
| 5    | "VAC" indicator     | Vacuum value display.  |
| 6    | "+" and "-" buttons | Buttons for increasing ("+") or lowering ("-") the corresponding value.  |
| 7    | "GAS" display       | Inert gas value display.   |
| 8    | "°C" display        | Sealing time display.  |
| 9    | "STOP" button       | Stops the vacuum procedure and starts the sealing procedure.   |
| 10   | "1+2" button        | Switches on or off sealing bar 1 and 2.  |
| 11   | "SB 2" button       | Switches on or off sealing bar 2.  |
| 12   | "SB 1" button       | Switches on or off sealing bar 1.  |
| 13   | "✂" button          | Switches/sets the cut-off sealing function.  |
| 14   | "VAC" button        | Sets the stage vacuum.   |
| 15   | "☁" button          | Switches on or off the vacuum up to the vaporisation point and the sensitivity (response behaviour) (only with liquids). |
| 16   | "DAL" button        | Continuous operation function and service program.   |
| 17   | "🌀" button          | Switches on or off the slow air release function.  |
| 18   | "MEM" button        | Saves and selects programs.  |
| 19   | "BREAK" button      | Stops the entire program cycle.  |

## 4.4 Options

The machines can be equipped with the following options:

### 4.4.1 Inert gas

The inert gas unit enables the packaging of pressure-sensitive goods despite high vacuum values.

The packaged item is vacuumed during the first phase. The corresponding inert gas flows into the vacuum chamber via an externally connected gas cylinder and thus creates a pressure-balanced packaging during the second phase.

Only the following food gases may be used as inert gas:

- BIOGON® C 30 E941 / E290

For more information, see chapter [Preparing the machine for injection of inert gas](#) [▶ 43].

### 4.4.2 External control panel

The machine control panel can be mounted on a stainless steel arm on the side of the machine housing.



Fig. 5: External control panel

# 5 Transport

## 5.1 Safety instructions

|   |  |
|---|--|
|  | <b>⚠ WARNING</b>   |
|   | <p><b>Danger due to falling loads!</b></p> <p>Falling parts or parts that are moving in an uncontrolled manner can result in serious injuries.</p> <p>▶ Do not walk under or in front of moving loads.</p> |

|   |  |
|---|--|
|  | <b>⚠ WARNING</b>   |
|   | <p><b>Risk of injury!</b></p> <p>There is a risk of injury when lifting heavy loads.</p> <p>▶ Heavy loads must only be lifted with several people or suitable lifting equipment.</p> |

- Observe the information about the designated lifting points.
- Do not lift the unit on protruding machine parts or on eyelets of fitted components. Check that the lifting equipment is securely attached.
- Only use approved lifting gear and fastening equipment with sufficient load-bearing capacity.
- Do not use any damaged ropes and/or belts.
- Do not lay ropes or straps over sharp edges or corners. Do not knot or twist them.

### **Eccentric centre of gravity**

Packages may have an eccentric centre of gravity. If the package is fastened incorrectly, it may tilt and cause life-threatening injuries.

- Observe the markings on the packages.
- Attach the crane hook so that it is located at the centre of the gravity.

### **Incorrect transport**

Improper transportation may result in significant material damage.

- Prior to each transport, make sure that the machine is correctly packaged.
- Do not tilt the machine during transport and only transport the machine horizontally.
- When unloading delivered packages and when transporting them on the premises, proceed with caution and observe the symbols and instructions on the packaging.
- Do not remove the packaging until shortly before installation.

## **5.2 Personnel qualifications**

Transport, packaging and storage may only be carried out by personnel who

- are authorised to do so due to their training and qualifications.
- are tasked to do so by the machine operator.

## **5.3 Transport inspection**

After receiving the machine:

- 1 Refer to the order papers for the scope of machine delivery and compare them with the delivery note.
- 2 Check that the delivery is complete using the delivery note.
- 3 Check the delivery for visible damage.
- 4 Report an incomplete or damaged delivery to the dealer/supplier immediately.

## **5.4 Packaging**

The used packaging materials are recyclable. Dispose of packaging materials that are no longer necessary according to the local applicable regulations.

# 6 Installation

## 6.1 Safety instructions



### **⚠ DANGER**

#### **Danger due to electrical current.**

There is a risk of death when making contact with lines or components that carry current.

- ▶ Work on electrical equipment must only be carried out by qualified electricians or personnel under the guidance and supervision of a qualified electrician in accordance with electrical engineering regulations.



### **⚠ WARNING**

#### **Risk of injury due to pneumatic energy.**

There is a risk of injuries when working on the pneumatic equipment.

- ▶ Only have work on the pneumatic system performed by trained specialists.

## 6.2 Electrical connection

Observe the following instructions when establishing the electrical connection to ensure safe and smooth machine operation:

- Check that the existing mains voltage matches the voltage specified on the type plate. This data must match to ensure that the machine is not damaged.
  - Refer to the **Technical data** [▶ 26] chapter for the fuse necessary for operating the machine.
  - Make sure that the power cable is not damaged and not routed over sharp edges.
  - The connection cable must not be tightly stretched, kinked, crushed or knotted or come into contact with hot surfaces.
  - The electrical safety of the machine is only ensured if it is connected to a protective conductor system (residual current circuit breaker with a trip current of 30 mA) that has been installed in accordance with the applicable regulations. The machine must not be powered from a socket without a protective conductor. In case of doubt, the installation must be checked by a qualified electrician. The manufacturer accepts no responsibility for damage caused by a missing or disconnected protective conductor.
  - Install the connection cable so that it does not create a tripping hazard.
- 1 Make sure that the main switch (1) is in position "0" (off).



Fig. 6: Main switch



Fig. 7: Electrical connection

- 2 Plug in the mains plug (2) into the socket.

### 6.3 Connection for inert gas (option)

The connection (1) for the inert gas (max. 1.5 bar) is located at the rear of the machine.



*Fig. 8:* Connection for inert gas (option)

# 7 Control/operation

## 7.1 Safety instructions

|   |   |
|---|---|
|  | <b>⚠ WARNING</b>  |
|   | <p><b>Risk of crushing!</b></p> <p>With machines whose lid is automatically moved, there is a risk of crushing between the machine and the lid when closing the lid.</p> <ul style="list-style-type: none"> <li>▶ Do not reach between the lid and machine when closing the lid.</li> </ul> |

|  |  |
|--|--|
|  | <b>NOTICE</b>  |
|  | <p><b>Possible damage to the vacuum pump.</b></p> <p>With an ambient temperature below +10°C and over +30°C, the vacuum pump may be damaged.</p> <ul style="list-style-type: none"> <li>▶ Only operate the machine at an ambient temperature between +10°C and +30°C.</li> </ul> |

## 7.2 Requirements for the installation site

The following requirements for the installation site must be met in order to ensure safe and smooth machine operation:

- Operate the machine on a solid level surface. The clearance to the walls and other objects must be at least 30 cm.
- The power socket must be easily accessible so that the mains connection can be quickly disconnected.
- The machine must not be operated or stored outside.
- When selecting the installation site, take the space requirements for the connections into consideration.
- The machine must be installed in a well-ventilated, dry room. Direct contact with water or vapour must be avoided.
- The machine may only be operated if the locking brakes on the transport rollers are closed (pressed down).



## 7.3 General instructions

- Select bags that are suitable for the product quantity.
- Only package cooled products.
- Ensure work is performed in a clean manner and wear gloves.
- Keep the sealing area of the vacuum bag clean.

## 7.4 Information about packaged goods

### 7.4.1 Basic machine settings

No programs are pre-installed. The programs are fully customised to the customer's requirements by the Erme customer service personnel when the machine is installed.

### 7.4.2 Instructions on storage times

The following information is based on experience and may deviate upwards or downwards from various factors, such as age and food, feeding of livestock and refrigeration chain, etc.

The company ERME AG therefore rejects all liability for any resulting damage.

The storage times refers to vacuum-packed, non-frozen products that are stored in a cool location.

| Product           | Storage times | Comments   |
|-------------------|---------------|--|
| Veal              | 10 - 14 days  |  |
| Beef              | 4 - 6 weeks   | Ripening process 2 - 3 weeks   |
| Pork              | 7 - 10 days   |  |
| Poultry           | 10 - 14 days  | Cover sharp bones  |
| Fish              | 5 - 10 days   | Smoked several weeks   |
| Sausage products  | 7 - 14 days   | Depending on product quality   |
| Smoked            | Weeks/months  |  |
| Pasta             | 5 - 10 days   | Possibly under protective atmosphere                                     |
| Baked goods       | 5 - 10 days   | Possibly under protective atmosphere                                     |
| Cheese            | Days/weeks    | – Depending on product quality<br>– Possibly under protective atmosphere |
| Fruit, vegetables | 7 - 15 days   | Possibly blanch  |
| Salads            | 5 - 10 days   | Only partially seal  |
| Liquids           | 7 - 14 days   | Use slanted insert   |

### 7.4.3 Packaging liquids

When packaging liquid goods, it must be ensured that the vacuuming process is stopped on time. Liquids foam under a vacuum. This effect is induced by reducing the atmospheric pressure in the vacuum chamber. The foaming of the liquid creates a risk of the liquid leaking out of the bag. This then results in material loss and contaminates the vacuum chamber.

When the "vapour" function is enabled (see chapter [Setting parameters \[▶ 45\]](#)), the controller automatically detects the boiling point of the liquid and switches a step further in the work cycle.

## 7.5 Switching on the machine

Proceed as follows to switch on the machine:

- 1 Switch on the machine's main switch.
  - 2 Switch on the controller by pressing the "ON" button when the lid is open.
- ⇒ The program most recently called up is loaded.

## 7.6 Switching off the machine

Proceed as follows to switch off the machine:

- 1 Press the "OFF" button.
- ⇒ The machine is switched into standby mode.

|          |  |
|----------|--|
| <b>i</b> | <b>NOTE</b>  |
|          | <p>After 5 minutes without any action, the machine automatically switches into standby mode.</p> <p>Once the lid is closed, the pump automatically switches back on.</p> |

- 2 Switch off the machine's main switch.

## 7.7 Preparing the machine

- 1 Adjust the chamber to the product volume by inserting or removing insertion plates. The middle of the product height should be at the height of the sealing bar.
- 2 Insert the vacuum bag into the chamber so that the bag opening lies flat on the sealing bar.
- 3 Switch on the machine (see chapter [Switching on the machine \[▶ 42\]](#)).

## 7.8 Preparing the machine for injection of inert gas



### **⚠ DANGER**

**There is a risk of fire due to use of the wrong inert gas.**

There is a risk of fire when injecting gas with oxygen.

- ▶ By default, only nitrogen or a mixture of nitrogen and carbon dioxide may be used as an inert gas.
- ▶ Oxygenated gases (over 21%) may only be used after taking special safety measures (special vacuum pump, special oil and safety valves).



Fig. 9: Securing the gas cylinder

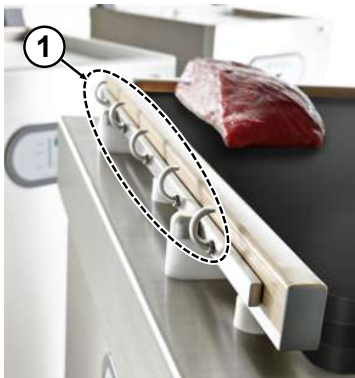

Fig. 10: Gas nozzles

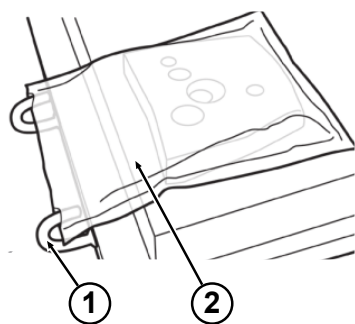

Fig. 11: Positioning the gas nozzles

- (1) Gas nozzles  
(2) Vacuum bag

1 Set up the gas cylinder near the machine and secure it against falling with suitable equipment.

2 Insert the gas lance into the machine.

3 Align the gas nozzles (1) so that they are directed into the vacuum bag (2).

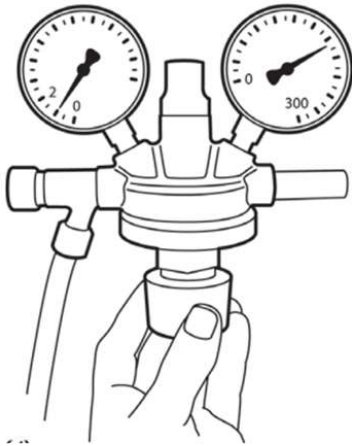

Fig. 12: Valve fitting

- 4 Open the main valve on the gas cylinder.
  - 5 Open the knurled screw on the valve fitting (to the left).  
The filling pressure of the gas cylinder is displayed on the right pressure gauge.
  - 6 Set the gassing pressure to 1 bar (displayed on the left pressure gauge).
  - 7 Set the desired inert gas level (see chapter **Operating the controller CP-E5** [▶ 45]).
- ⇒ A higher value produces a looser packaging and a lower value produces a tighter packaging.

**⚠ DANGER**

- ▶ Food packaged with inert gas must be labelled accordingly.
- ▶ The main tap on the gas cylinder must always be closed when the inert gas is not being injected.

## 7.9 Operating the controller CP-E5

### 7.9.1 Setting parameters

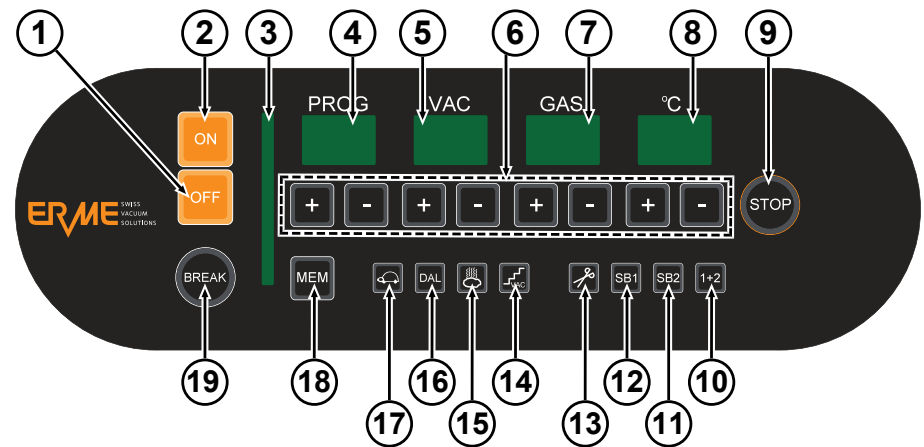

Fig. 13: Controller CP-E5

#### Switching the machine on and off

Press the "ON" button (2) to switch the controller on and press the "OFF" button (1) to switch it off, see [Switching on the machine \[▶ 42\]](#) and [Switching off the machine \[▶ 42\]](#).

#### Vacuum value

The vacuum value is displayed in the "VAC" display field (5). Press the corresponding buttons "+" and "-" (6) below the display field to change the vacuum value.

Setting range: 20 - 98%, 19 - 0.1 mbar

The setting value for the highest vacuum level possible cannot always be reached depending on the product and ambient conditions.

Guideline for the highest vacuum level: 10 - 5 mbar

#### Inert gas

The inert gas level is displayed in the "GAS" (7) display field. Press the corresponding buttons "+" and "-" (6) below the display field to change the inert gas level.

Setting range: 0 - 80%

Set the inert gas level to "0" if no inert gas is to be injected.

### Sealing time (sealing bar)

The sealing time is displayed in the "°C" (8) display field. Press the corresponding buttons "+" and "-" (6) below the display field to change the sealing time.

Setting range: 0 - 4 seconds

Guideline: 1.3 seconds

### Sealing time (cut-off sealing)

With machines featuring a separate adjustable cut-off sealing function, the sealing time for the cut-off sealing bar can be set depending on the sealing bar's sealing time.

Press the  button (13) and keep it pressed down. Press the corresponding buttons "+" and "-" (6) below the "°C" display field (8) to change the sealing time for the cut-off sealing.

Guideline: 1.3 seconds

If the cut-off sealing function is not required, it can be switched off by pressing the  button (13).

### Sealing bar selection

With machines featuring several sealing bars, the active sealing bars can be selected using the "SB1" (12), "SB2" (11) and "1+2" buttons (10).

### Soft air release function

The "soft air release" function is switched on and off using the  button (17). When the function is activated, the ventilation time of the vacuum chamber is extended. Use this function for particularly pressure-sensitive products.

## Stage vacuum

The vacuum procedure can be carried out in stages. This way, the air has enough time to escape the product. With machines featuring an inert gas unit, the gas can also be flushed.

The "stage vacuum" function is switched on and off using the  button (14). When the "stage vacuum" function is activated in the "VAC" (5) and "GAS" (7) display fields, the number of the cycles for vacuuming and injecting inert gas and the waiting time in the "°C" display field (8) are set between the individual cycles.

To program the machine, press and hold the  (14) button down.

- Vacuum and inert gas injection cycle: 0 - 5
- Waiting time: 0 - 60 seconds

Input areas:

With two cycles, the vacuum is applied up until the final vacuum. After the set waiting time elapses, a vacuum is applied again up until the final vacuum, providing that the final vacuum is no longer present. If more than two vacuum cycles are set, the final vacuum is generated in one to three stages with the respective subsequent waiting time. Inert gas can be injected afterwards.

## Vacuum up until the vaporisation point

|   |  |
|---|--|
|  | <b>NOTE</b>                                    |
|   | Only use this function when vacuuming liquids. |

Liquids start boiling faster under a vacuum than under normal pressure conditions. The colder the liquid, the higher the achievable vacuum stage. Temperatures of approximately 6°C are ideal.

The "vapour" function is switched on and off using the  button (15). When the function is activated, the next process step is automatically carried out if the liquid starts evaporating.

Keep the  button (15) pressed down to set the sensor's sensitivity (i.e. the response behaviour). Press the corresponding buttons "+" and "-" (6) below the "°C" display field (8) to change the sensitivity.

Setting range: 0.1 (high sensitivity) - 9.9 (low sensitivity)

Guideline for liquids of approx. 15°C: 1.0

### Service program / continuous operation function

The service program is used to remove condensate from the oil circuit. This program can also be used to warm up the machine (e.g. for approx. 2 minutes with a low room temperature).

To switch on the continuous operation function when the lid is open, press the "DAL" button (16) and then close the machine lid.

For information about the service program, see [Service program](#) [▶ 57].

### Stop the vacuum or packaging procedure

The vacuum process can be stopped by pressing the "STOP" button (9) and the machine starts the sealing procedure.

Press the "BREAK" (19) button to cancel the entire procedure.

For information about the vacuuming procedure, see [Performing the vacuum procedure](#) [▶ 50]

## 7.9.2 Editing programs

|          |                                 |
|----------|---------------------------------|
| <b>i</b> | <b>NOTE</b>                     |
|          | Up to 99 programs can be saved. |

### Saving programs

- 1 Select a program memory location using the "+" and "-" buttons below the "PROG" display field.
- 2 For information on setting all desired parameters, see [Setting parameters](#) [▶ 45].
  - ⇒ The program memory location is displayed in the "PROG" display field.
- 3 Keep the "MEM" button pressed until the "PROG" display flashes twice.
  - ⇒ The program is saved at the selected program memory location.

### Loading the program

- 4 Select a program using the "+" and "-" buttons below the "PROG" display field.
- 5 For information about performing the vacuum procedure, see chapter [Performing the vacuum procedure](#) [▶ 50].



## 7.9.3 Operating hours and cycle counters

The machine is equipped with an operating hours counter and a cycle counter.

### Displaying the operating hours

- 1 Press and hold down the  button for a few seconds.
  - ⇒ The pump's operating hours are displayed on the "PROG", "VAC", "GAS" and "°C" displays. The display range (in hours) is between 00-00-00-00 and 99-99-99-99.

### Displaying the sealing cycles

- 2 Press and hold down the  button for a few seconds.
  - ⇒ The number of sealing cycles is displayed on the "PROG", "VAC", "GAS" and "°C" displays. The display range (in hours) is between 00-00-00-00 and 99-99-99-99.

### Resetting the counters

- 3 Call up the counter reading of the desired counter.
- 4 Press and hold down the "BREAK" button until 00-00-00-00 is displayed in the "PROG", "VAC", "GAS" and "°C" displays.

## 7.9.4 Button lock

A button lock can be activated when switching the machine on.

- ✓ The controller is switched off.
  - 1 Keep the "STOP" button pressed down.
  - 2 Press the "ON" button at the same time.
    - ⇒ "FrEE" or "BLOCKed" is displayed.
  - 3 Switch the button lock on or off using the "+" and "-" buttons below the "°C" display.

|   |  |
|---|--|
|  | <b>NOTE</b>  |
|   | When the button lock is activated ("BLOCKed" display), only the "ON", "OFF", "BREAK", "STOP" buttons and the "+" and "-" buttons below the "MEM" display function. |

## 7.10 Performing the vacuum procedure

- 1 Preparing the machine (see chapter Preparing the machine).
- 2 Set the desired program (see chapter Operating the controller CP-E5 [▶ 45]).
- 3 Preparing the machine for injecting inert gas (see chapter Preparing the machine for injection of inert gas [▶ 43]) if a vacuum is to be applied under inert gas.
- 4 Close the lid.
  - ⇒ The vacuum procedure starts.

|          |   |
|----------|---|
| <b>i</b> | <b>NOTE</b>   |
|          | <ul style="list-style-type: none"> <li>▶ The vacuum procedure can be stopped by pressing the "STOP" button and the machine starts the sealing procedure.</li> <li>▶ Press the "BREAK" button to cancel the entire procedure.</li> </ul> |

- ⇒ After the vacuum procedure is completed, the machine lid automatically opens.
- 5 Remove the vacuumed product.
  - 6 Close the main tap on the inert gas cylinder if the vacuum is generated under inert gas.
  - 7 Switch off the machine.

## 7.11 Activities after use

- 1 Switch off the machine (see chapter Switching off the machine [▶ 42]).
- 2 Clean the machine (see chapter Cleaning the machine [▶ 54]).
- 3 Close the lid and secure it with the lid closure (1).



Fig. 14: Lid closure

# 8 Troubleshooting

## 8.1 Safety instructions



### **⚠ DANGER**

#### **Danger due to electrical current.**

There is a risk of death when making contact with lines or components that carry current.

- ▶ Work on electrical equipment must only be carried out by a qualified electrician in accordance with electrical engineering regulations.



### **⚠ WARNING**

#### **Risk of burns on hot surfaces.**

The sealing bar becomes very hot during operation.

- ▶ Avoid contact with hot surfaces, or wear protective gloves.
- ▶ Let hot components cool down before starting work.

### **NOTICE**

#### **Material damage due to incorrect troubleshooting.**

If pending faults are ignored or not correctly rectified, it can result in damage to the machine.

- ▶ In case of active faults, shut down the machine.
- ▶ Properly rectify the fault or have it rectified by appropriate specialists.

## 8.2 Instructions on troubleshooting

|          |  |
|----------|--|
| <b>i</b> | <b>NOTE</b>  |
|          | <p>If the measures listed here do not rectify the fault, contact the customer service department of the company ERME AG.</p> <p>See chapter "Customer service [▶ 13]".</p> |

## 8.3 Localising faults

| Problem                         | Possible causes   | Remedy  |
|---------------------------------|---|---|
| Display does not light up.      | – Machine is not switched on.   | – Switch on the machine.  |
|                                 | – Controller is not switched on.  | – Switch on controller.   |
|                                 | – Circuit breaker in the power distribution unit has tripped.                   | – Switch the circuit breaker back on.                                     |
| Poor vacuum.                    | – The lid seal is worn or defective.  | – Have the lid seal replaced by Customer Service.                         |
|                                 | – The wrong program has been selected or a vacuum value that is too low is set. | – Check and correct the settings.   |
|                                 | – Poor oil quality.   | – Run the service program   |
|                                 |   | – Change the oil.   |
| – Oil quantity is insufficient. | – Check the oil level and replenish or replace the oil.                         |   |
| The vacuum bag is overinflated. | – The vacuum bag is pinched by the lid.   | – Insert the vacuum bag so that it lies completely in the vacuum chamber. |
|                                 | – The sealing pressure cylinder does not lower.                                 | – Clean and oil the bars.   |

# 9 Cleaning

## 9.1 Safety instructions

|   |  |
|---|--|
|  | <b>⚠ WARNING</b>   |
|   | <p><b>Risk of burns on hot surfaces.</b></p> <p>The sealing bar becomes very hot during operation. There is a risk of burns in case of contact with hot components.</p> <ul style="list-style-type: none"><li>▶ Avoid contact with hot surfaces, or wear protective gloves.</li><li>▶ Let hot components cool down before starting work.</li></ul> |

|  |   |
|--|---|
|  | <b>NOTICE</b>   |
|  | <p><b>Possible material damage during cleaning.</b></p> <p>Incorrect cleaning can result in material damage to the machine.</p> <ul style="list-style-type: none"><li>▶ Make sure that no liquids enter into the suction openings.</li><li>▶ Do not clean the machine with a high-pressure or powerful water jet.</li></ul> |

## 9.2 Personnel qualifications

The machine may only be cleaned by personnel who

- have received the corresponding training.
- are tasked to do so by the machine operator.

## 9.3 Cleaning the machine

Proceed as follows for cleaning:

- 1 Switch off the machine and unplug the mains plug (see chapter **Switching off the machine** [▶ 42]).
- 2 Let the surfaces to be cleaned cool down.
- 3 To clean the machine, manually remove the coarse dirt and then wipe down with neutral, food-safe cleaning agents and a soft cloth.

|   |  |
|---|--|
|  | <b>NOTE</b>  |
|   | <ul style="list-style-type: none"><li>▶ Do not use aggressive cleaning agents when cleaning the machine.</li><li>▶ If you detect damage, notify the responsible personnel.</li></ul> |

# 10 Maintenance

## 10.1 Safety instructions



### **⚠ DANGER**

#### **Danger due to electrical current.**

There is a risk of death when making contact with lines or components that carry current.

- ▶ Work on electrical equipment must only be carried out by a qualified electrician in accordance with electrical engineering regulations.



### **⚠ WARNING**

#### **Risk of burns on hot surfaces.**

The sealing bar becomes very hot during operation. There is a risk of burns resulting from contact with hot components.

- ▶ Avoid contact with hot surfaces, or wear protective gloves.
- ▶ Let hot components cool down before starting work.

### **NOTICE**

#### **Material damage due to the incorrect performance of the maintenance work.**

If maintenance work is not carried out correctly, it can result in damage to the machine.

- ▶ Perform the maintenance work correctly and appropriately.

## 10.2 Personnel qualifications

Maintenance work on the machine may only be performed by personnel who

- are authorised to do so due to their training and qualifications.
- are tasked to do so by the machine operator.

## 10.3 Measures prior to maintenance

Prior to performing maintenance work:

- 1 Switch off the machine (see chapter **Switching off the machine** [▶ 42]).
- 2 Unplug the mains plug.
- 3 Let the surfaces to be cleaned cool down.

## 10.4 Maintenance report

Perform the following maintenance work on the machine:

| Work to be performed  | Interval                                 | Additional information   |
|---|--|--|
| Perform a visual inspection of the machine for: <ul style="list-style-type: none"> <li>– Contamination</li> <li>– Damage</li> </ul> | Before starting up the machine each time |  |
| Check the electrical connections and mains cable for damage.  | Before starting up the machine each time | Have the identified defects corrected immediately.   |
| Check the pneumatic system for damage   | Before starting up the machine each time | For machines with inert gas. Have the identified defects corrected immediately.            |
| Clean the machine.  | After each use                           | See chapter <b>Cleaning the machine</b> [▶ 54].  |
| Clean the sealing bar and silicone strip  | After each use                           | In case of wear, have the silicone strip replaced by the ERME customer service department. |
| Run the service program.  | Monthly                                  | See chapter <b>Service program</b> [▶ 57].   |
| Check the oil level.  | Monthly                                  | See chapter <b>Checking the oil level</b> [▶ 58].  |



## 10.5 Description of the maintenance work

### 10.5.1 Service program

|  |  |
|--|--|
|  | <b>NOTICE</b>  |
|  | <p><b>Possible damage to the vacuum pump.</b></p> <p>Water vapour that forms during the vacuum process contaminates the oil, diminishes the vacuum power and can result in pump damages in extreme cases</p> <p>▶ Run the service program monthly.</p> |

The service program is used to remove condensate from the oil circuit. The pump is heated to operating temperature and aerated in pulses. Slight odour emissions may occur while the program is running. Make sure the room is sufficiently ventilated.

Proceed as follows to start the service program:

1 Press the "DAL" button.

⇒ The green LED above the button must light up.

2 Close the machine lid.

⇒ The machine runs for 5 minutes, carries out an intermediate aeration process, then runs for 2 minutes and carries out another intermediate aeration process and then runs for 2 minutes, etc. This procedure is repeated five times and then the lid opens automatically.

|          |   |
|----------|---|
| <b>i</b> | <b>NOTE</b>   |
|          | <p>▶ Press the "BREAK" button to cancel the service program. The lid opens automatically.</p> |

### 10.5.2 Checking the oil level

|               |  |
|---------------|--|
| <b>NOTICE</b> |  |
|               | <p><b>Vacuum pump damage in case of an insufficient oil level</b></p> <p>Operating the vacuum pump with an insufficient oil level can result in damage to the vacuum pump</p> <ul style="list-style-type: none"> <li>▶ Do not operate the machine if the oil level is below the "MIN" mark.</li> </ul> |

Check the oil level and the condition of the oil each month.



There is an opening (1), through which the oil level indicator can be seen, in the side plate on the left side of the machine. It is not necessary to remove the side plate to check the oil level.

Fig. 15: Checking the oil level





Check the oil level and the condition of the oil at the oil inspection glass (2). The oil inspection glass is located behind the cover on the left side of the machine. The oil level must be between the "MIN" and "MAX" marks. If the oil level drops below the "MIN" mark, oil must be added.

Fig. 16: Checking the oil level

|          |   |
|----------|---|
| <b>i</b> | <b>NOTE</b>   |
|          | <p>Contact the ERME customer service department to replenish or change the oil.</p> |

# 11 Decommissioning and disposal

## 11.1 Safety instructions

|   |  |
|---|--|
|    | <b>⚠ DANGER</b>  |
|   | <p><b>Risk of death due to electrical current and other energies.</b></p> <p>Decommissioning/disassembling the machine may result in severe injuries or death if the power supply is not switched off or due to stored energies.</p> <ul style="list-style-type: none"><li>▶ Prior to disassembling the machine, disconnect it from any external power supplies.</li><li>▶ Depressurise all devices that are under pressure.</li><li>▶ Dissipate any other residual energies.</li></ul>  |
|  | <b>⚠ WARNING</b>   |
|   | <p><b>Risk of injury due to improper machine disassembly.</b></p> <p>Improperly disassembling the machine may result in serious injuries.</p> <ul style="list-style-type: none"><li>▶ The machine must only be disassembled and dismantled by appropriately trained specialists in compliance with the local safety regulations.</li><li>▶ Prior to starting work, ensure sufficient space for disassembly.</li><li>▶ Make sure the work area is orderly and clean. Loose components and tools that are stacked on each other or lying around are potential sources of accidents.</li><li>▶ Correctly disassemble the components.</li><li>▶ Secure the components so that they do not fall down or over.</li></ul> |

## 11.2 Personnel qualifications

The unit may only be decommissioned and disposed of by personnel who

- are authorised to do so due to their training and qualifications.
- are tasked to do so by the machine operator.

## 11.3 Decommissioning

### 11.3.1 Temporary decommissioning

Proceed as follows in case the machine must be temporarily decommissioned:

- 1 Switch off the machine and unplug the mains plug.
- 2 Disconnect the machine from the inert gas supply.
- 3 If the unit must be decommissioned for a longer period of time, apply anti-corrosion measures and regularly check the anti-corrosion agent.

### 11.3.2 Final decommissioning / disassembly

- 1 Perform the work steps set out in the "Temporary decommissioning" section.
- 2 Disconnect the machine from any external power supplies.
- 3 Remove all connection hoses/pipes.
- 4 Properly dispose of material, components, lubricating and auxiliary materials.

## 11.4 Disposal

Perform the following steps to ensure proper disposal after disassembly:

- Separate metals and plastics and take them to authorised scrapping or recycling facilities.
- Dispose of problematic substances that can no longer be reused, such as lubricants and cleaning agents or electrical components, according to the local applicable regulations.

|   |               |
|---|---------------|
|    | <b>NOTICE</b> |
| <p><b>Environmental damage if improperly disposed of!</b></p> <p>Incorrect disposal may result in environmental damage.</p> <ul style="list-style-type: none"> <li>▶ Observe the manufacturer's specifications for the lubricants and auxiliary materials to ensure environmentally-friendly disposal.</li> </ul> |               |

# 12 Declaration of Conformity

(Original declaration of conformity)

in accordance to the Machinery Directive 2006/42/EC, Annex II 1A

Name of the manufacturer

ERME AG  
SWISS VACUUM SOLUTIONS

Manufacturer address

Grossmattstrasse 25  
CH - 8964 Rudolfstetten

Product

We declare that the product:

Vacuum packaging machines

Type

Single-chamber machines: industrial models (I3000, I5000, I7000)

Relevant EU directives

complies with the relevant regulations:

EC Directive as amended by 2006/42/EC  
EMC Directive as amended by 2014/30/EU

Applied harmonised standards:

DIN EN ISO 12100: 03/2011:

Safety of machinery — General principles for design — Risk assessment and risk reduction

DIN EN 60204-1: 06/2007:

Safety of machinery — Electrical equipment of machines — Part 1: General requirements

EN ISO 14159:

Safety of machinery — Hygiene requirements for the design of machinery

Authorised representative for the compilation of technical documents:

ERME AG

Technical documentation is available.

The operating instructions for the machine are available.

- In the original version
- In the national language of the user

It is assumed that the product will only be operated in accordance with its intended use. Refer to the technical documentation for information about the intended use.

Rudolfstetten, 8 January 2018

Signature



Thomas Meyer